



# SERVICE BULLETIN

Classification: AT00-001b	Reference: NTB00-056b	Date: November 27, 2002
------------------------------	--------------------------	----------------------------

## 1988 AND LATER NISSAN VEHICLES AUTOMATIC TRANSMISSION OIL COOLER CLEANING

**ATTENTION:** This bulletin supersedes NTB91-099, NTB93-007, NTB94-050, and NTB95-109B, and amends NTB00-056a. The applied models/model years and information in the Claims Information section of NTB00-056a was updated. Please discard all paper copies of NTB91-099, NTB93-007, NTB94-050, NTB95-109B, and earlier versions of NTB00-056.

**APPLIED VEHICLES:** All 1988 and later with automatic transmission (including the Xtronic CVT automatic transmission)

### SERVICE INFORMATION

Whenever an automatic transmission (A/T) is repaired, overhauled, or replaced, **the A/T oil cooler mounted in the radiator must be inspected and cleaned.**

- Metal debris and friction material, if present, can become trapped in the A/T oil cooler and may build up as transmission fluid enters the Cooler Inlet.
- This debris can contaminate the newly serviced transmission.
- In severe cases this debris can block or restrict the flow of transmission fluid/oil. In either case, failure of the newly serviced A/T may result.

It will be necessary to back flush the cooler through the Cooler Outlet in order to flush out any built up debris.

- The location of the cooler Inlet and Outlet hoses described in this bulletin determines direction of transmission fluid flow through the cooler.
- The Inlet and Outlet position varies from model to model, and you **must** identify the location of the Cooler Inlet and Outlet to successfully perform the cleaning procedure.

Refer to the **SERVICE PROCEDURE Workflow** on page 2 to determine the procedure for a particular vehicle.

- Use Charts A and B on pages 2 and 3 to establish the correct Cooler Inlet and Outlet location for the vehicle you are servicing.
- Then perform the Cleaning, Diagnosis, and Inspection as instructed.

## SERVICE PROCEDURE

### Workflow:

	ACTION	MODELS		
		<u>All Applied Models</u>	ONLY Frontier (D22) w/Bypass Valve	ONLY '96-'98 Pathfinder (R50) with Air Cooler
1	Determine <b>A/T Oil Cooler Inlet and Outlet locations</b> (in radiator).	Use <b>Charts A &amp; B</b> , pages 2 & 3.		
2	Perform <b>Cooler cleaning</b> (in radiator).	<b>Cooler Cleaning (in radiator)</b> - Pages 4 and 5.		
2a	Perform <b>Cooler Bypass cleaning</b> . (if equipped)	N/A	<b>Cooler Bypass Cleaning</b> - Page 6.	N/A
2b	Perform cleaning of <b>optional Air Cooled Oil Cooler</b> .	N/A	N/A	<b>Cleaning Optional Air Cooled Oil Cooler</b> - Pages 7 and 8.
3	Perform <b>Diagnosis Procedure (All Vehicles)</b> .	Pages 8 and 9.		
4	Perform <b>Inspection Procedure (all vehicles)</b> .	Page 10.		

### Cooler Inlet And Outlet Locations

#### Chart A – Rear Wheel Drive (RWD) Cooler Inlet/Outlet Identification:

Model Year	Model	Cooler Inlet	Cooler Outlet *	Outlet Reference
1996 and later	Pathfinder	Driver Side	Passenger Side	see Figure 1A
1990 – 1997	Truck 6 Cyl. 2WD	Driver Side	Passenger Side	see Figure 1A
1990 – 1995	Pathfinder 6 Cyl. 2WD	Driver Side	Passenger Side	see Figure 1A
1988-1990	Truck and Pathfinder 6 Cyl. 4WD	Driver Side	Passenger Side	see Figure 1A
1988 and later	All others not covered above.	Passenger Side	Driver Side	see Figure 1B

\* **NOTE:** Always flush coolers from the Cooler Outlet Side (see Figures 1A and 1B for reference).

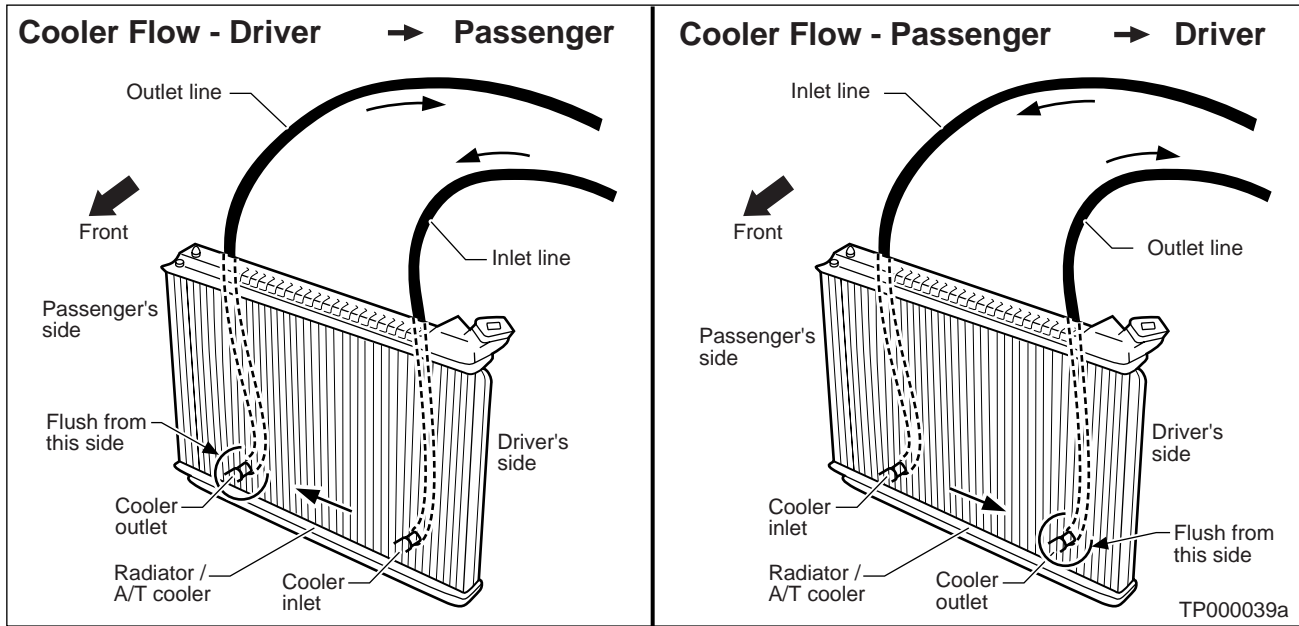

Figure 1A

Figure 1B

Figure x

**Chart B – Front Wheel Drive (FWD) Cooler Inlet/Outlet Identification:**

Model Year	Model	Cooler Inlet	Cooler Outlet *	Outlet Reference
1988 and later	All except Quest	Passenger Side	Driver Side	see Figure 1B
1993 and later	Quest	Driver Side Top	Driver Side Bottom	see Figure 2

\* **NOTE:** Always flush coolers from the Cooler Outlet Side (see Figure 1B or Figure 2 for reference).

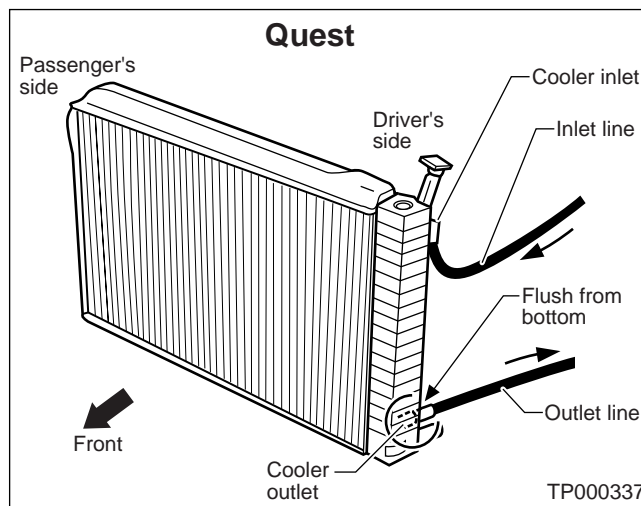

Figure 2

## Cooler Cleaning (in radiator)

**CAUTION:** You must refer to **Charts A and B on pages 2 and 3** to determine the location of the oil cooler inlet and outlet hoses for the vehicle you're working on.

**If these hoses are not identified correctly, debris may be left in the cooler and transmission damage may occur.**

1. Place an oil drain pan under the automatic transmission cooler Inlet and Outlet hoses.
2. Identify which hose is the Inlet and which hose is the Outlet to the oil cooler (refer to Charts A and B on pages 2 and 3).
3. Disconnect the oil cooler Inlet and Outlet rubber hoses from the steel cooler tubes (see Figure 3).
  - For Frontier (D22) w/bypass valve, remove the oil cooler inlet and outlet rubber hoses from the bypass valve fittings (see Figure 6 on page 6)

**NOTE:** If rubber material from a cooler hose remains on the steel tube or fitting, replace the rubber hose.

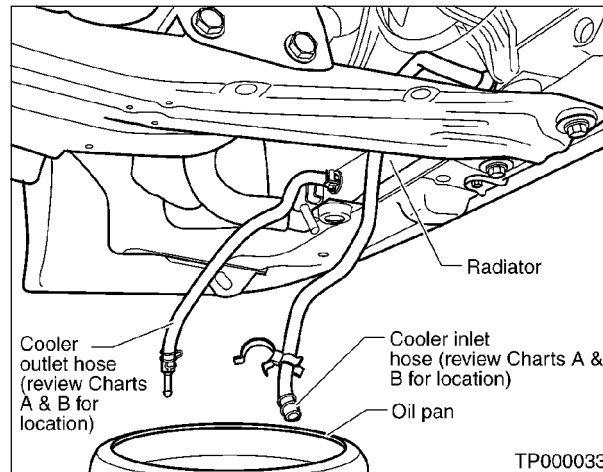

Figure 3

4. Allow any transmission fluid that remains in the cooler hoses to drain into the oil pan.
5. Insert the "extension adapter hose" from a can of Transmission Cooler Cleaner (Nissan P/N 999MP-AM006) into the cooler Outlet hose (see Figure 4).

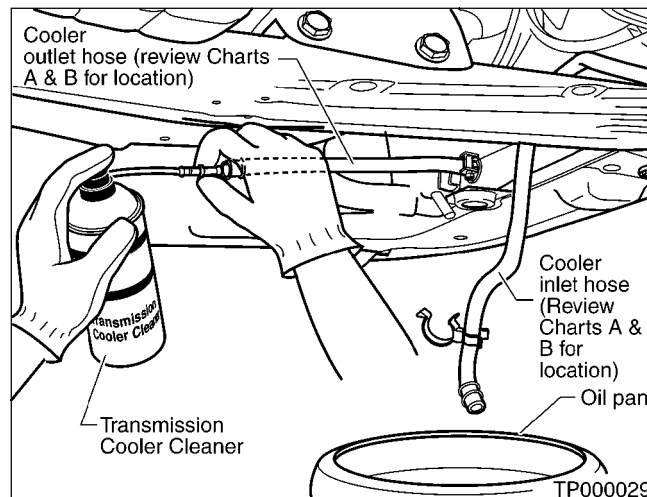

Figure 4

## CAUTION:

- **Wear safety glasses and rubber gloves when spraying the Transmission Cooler Cleaner.**
  - **Spray Cooler Cleaner only in areas with adequate ventilation.**
  - **Avoid contact with eyes and skin.**
  - **Do not breath vapors or mist from spray.**
6. Hold the hose and can as high as possible and spray Transmission Cooler Cleaner in a continuous stream into the cooler Outlet hose until fluid flows out of the cooler Inlet hose for 5 seconds.
- NOTE:** For Quest vehicles (V40/V41 Models), before removing the extension adapter hose from the cooler Outlet hose, turn the can over and spray only propellant (gas) for a few seconds. This will avoid fluid spill back out of the cooler hose.
7. Insert the tip of an air gun into the end of the cooler Outlet hose (see Figure 5).
  8. Wrap a shop rag around the air gun tip and end of the cooler Outlet hose (see Figure 5).

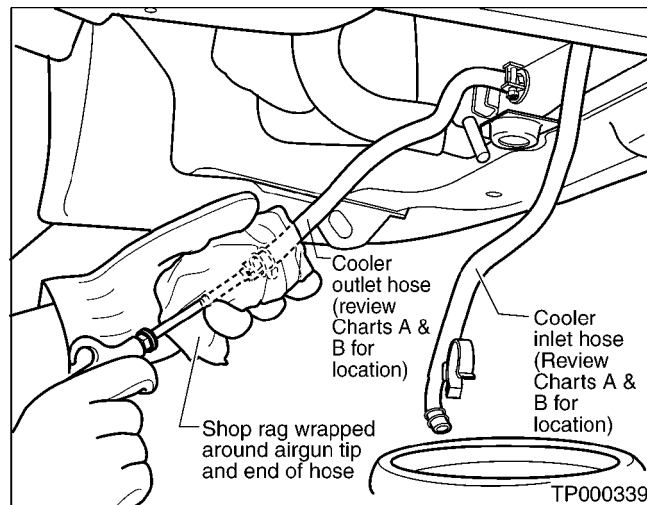

Figure 5

9. Blow compressed air regulated to 5-9 kg/cm<sup>2</sup> (70 – 130 PSI) through the cooler Outlet hose for 10 seconds to force out any remaining fluid.
10. Repeat steps 5 through 9 three additional times.
11. Place an oil drain pan under the banjo bolts that connect the oil cooler steel lines to the transmission.
12. Remove the “banjo” bolts at the transmission, and pull the line fittings away from the transmission.
13. Flush each steel line from the cooler side back toward the transmission by spraying Transmission Cooler Cleaner in a continuous stream for 5 seconds.
14. Blow compressed air regulated to 5-9 kg/cm<sup>2</sup> (70 – 130 PSI) through each steel line from the cooler side back toward the transmission for 10 seconds to force out any remaining fluid.
15. Ensure all debris is removed from the steel cooler lines.
16. Ensure all debris is removed from the banjo bolts and fittings.
17. Go to the **Workflow** chart on page 2 for next step.

## Frontier (D22) Cooler Bypass Cleaning

1. Place an oil drain pan under oil cooler hoses or lines before removing them.
2. Remove the lines from the transmission and allow the oil to drain from the lines (see Figure 6).

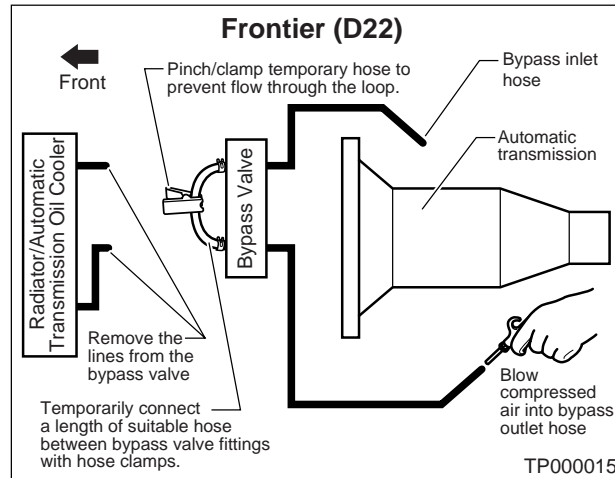

Figure 6

3. Remove the lines from the bypass valve (see Figure 6).
4. Use hose clamps and temporarily connect a length of suitable hose between the bypass valve fittings that go to the oil cooler (see Figure 6).
5. Pinch/clamp the temporary hose to prevent flow through the loop (see Figure 6).
6. Cover the end of the bypass inlet line with a shop rag to catch any oil spray.
7. Blow compressed air regulated to 5-9 kg/cm<sup>2</sup> (70 – 130 PSI) into the outlet for 10 second intervals, three times (see Figure 6).
8. Re-connect the transmission lines and remove the temporary hose loop (see Figure 7).

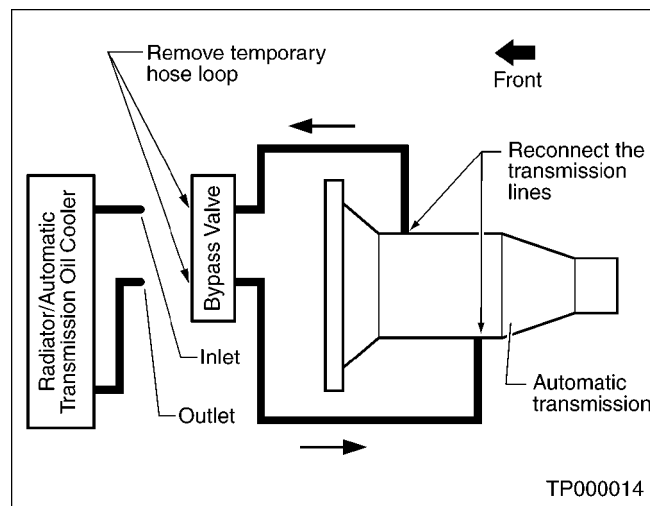

Figure 7

9. Go to **Diagnosis Procedure (All Vehicles)**, on pages 8 and 9.

## 1996-98 Pathfinder (R50) Cleaning the Optional Air Cooled Oil-Cooler (Air Cooler)

1. Place an oil drain pan under the A/T air cooler Inlet and Outlet hoses (see Points A and B, Figure 8).

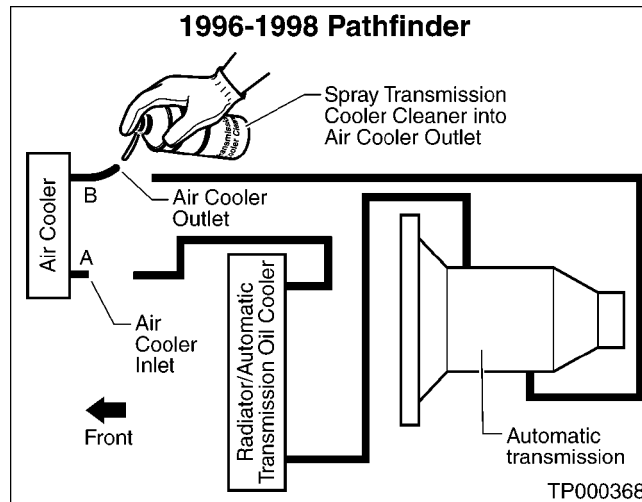

Figure 8

2. Disconnect the Inlet and Outlet hoses from the air cooler (see Points A and B, Figure 8).
3. Insert the “extension adapter hose” from a can of Transmission Cooler Cleaner (Nissan P/N 999MP-AM006) into the air cooler Outlet hose (see Point B, Figure 8).

### CAUTION:

- **Wear safety glasses and rubber gloves when spraying the Transmission Cooler Cleaner.**
  - **Spray Cooler Cleaner only with adequate ventilation**
  - **Avoid contact with eyes and skin.**
  - **Do not breath the vapors or the spray mist.**
4. Hold the hose and can as high as possible. Spray Transmission Cooler Cleaner in a continuous stream into the air cooler Outlet hose until fluid flows out of the air cooler Inlet hose for 5 seconds (Point A, Figure 8).

5. Insert the tip of an air gun into the end of the air cooler Outlet hose (see Point B, Figure 9).

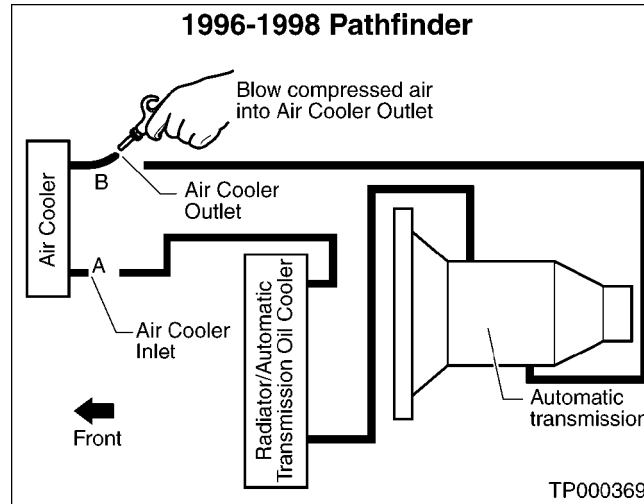

Figure 9

6. Wrap a shop rag around the air gun tip and end of the air cooler Outlet hose.
7. Blow compressed air regulated to 5-9 kg/cm<sup>2</sup> (70 – 130 PSI) through the air cooler Outlet hose to force any remaining oil or cleaner through the air cooler and out of the air cooler Inlet hose (see Point A, Figure 9).
8. Proceed with **Diagnosis Procedure (All Vehicles)**, below.

### Diagnosis Procedure (All Vehicles)

You will be taking a sample of the debris to determine if the radiator/oil cooler must be replaced.

**CAUTION:** You must refer to **Charts A and B on pages 2 and 3** to determine the location of the Inlet and Outlet hoses for the oil cooler in the radiator of the vehicle you are working on.

If you do not identify the Inlet and Outlet hoses correctly, debris may be left inside the “in radiator” cooler and transmission damage may occur.

**NOTE:** Failure to clean the exterior of the Cooler Inlet hose properly may lead to inaccurate debris identification.

1. Place an oil drain pan under the automatic transmission “in radiator” cooler Inlet and Outlet hoses.
2. Clean the exterior and tip of the cooler Inlet hose.
3. Insert the “extension adapter hose” from a can of Transmission Cooler Cleaner (Nissan P/N 999MP-AM006) into the Outlet hose of the oil cooler in the radiator (see Figure 4 on page 4).

### CAUTION:

- **Wear safety glasses and rubber gloves when spraying the Transmission Cooler Cleaner.**
- **Spray Cooler Cleaner only with adequate ventilation**
- **Avoid contact with eyes and skin.**
- **Do not breath vapors or mist from spray.**

4. Hold the hose and can as high as possible and spray Transmission Cooler Cleaner in a continuous stream into the cooler Outlet hose until fluid flows out of the cooler Inlet hose for 5 seconds.

**NOTE:** For Quest vehicles (V40/V41 Models);

- before removing the extension adapter hose from the cooler Outlet hose,
- turn the can over and spray only propellant for a few seconds to avoid fluid spilling back out of the cooler hose.

5. Tie a common white, basket-type coffee filter to the end of the cooler Inlet hose (see Figure 10).

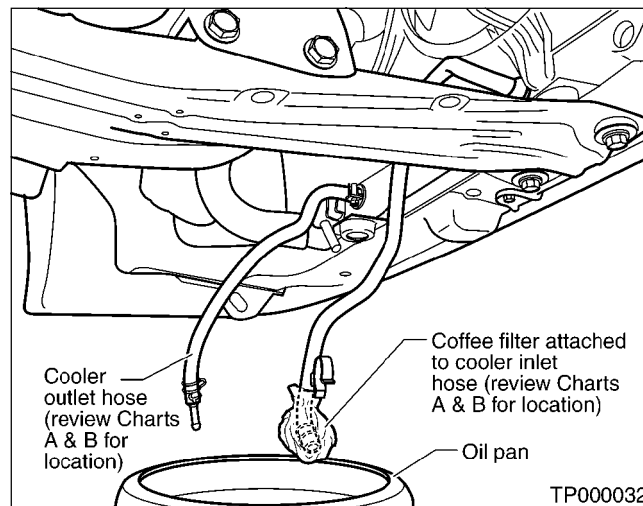

Figure 10

6. Insert the tip of an air gun into the end of the cooler Outlet hose (see Figure 11).
7. Wrap a shop rag around the air gun tip and end of the cooler Outlet hose (see Figure 11).

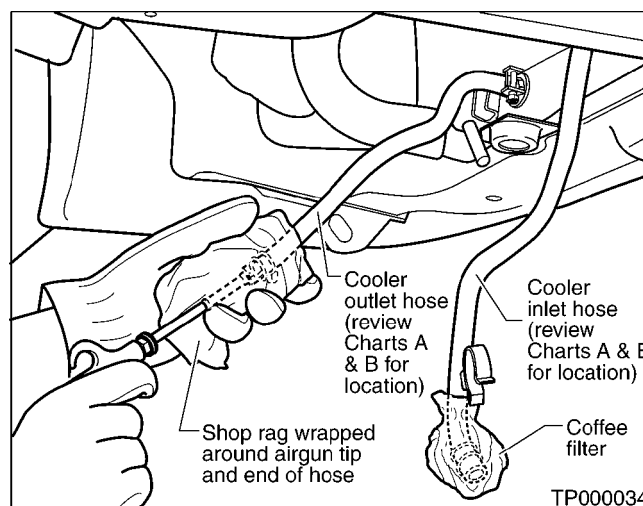

Figure 11

8. Blow compressed air regulated to 5-9 kg/cm<sup>2</sup> (70 – 130 PSI) through the cooler Outlet hose to force any remaining cleaner or fluid into the coffee filter (see Figure 11).
9. Remove the coffee filter from the end of the cooler Inlet hose.
10. Proceed with **Inspection Procedure** on page 10.

## Inspection Procedure

1. Inspect the coffee filter for debris (see Figure 12).

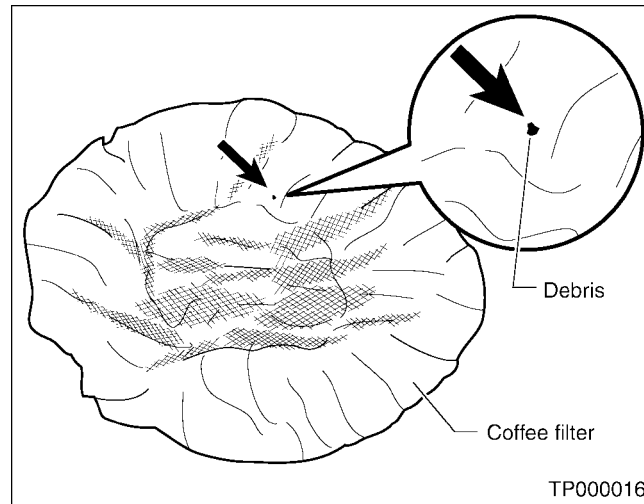

Figure 12

- A. If small metal debris less than 1 mm (0.040 inch) in size or metal powder is found in the coffee filter, this is normal. If normal debris is found, the radiator/oil cooler can be re-used.
- B. If **one or more pieces** of debris are found that are over 1 mm in size and/or peeled clutch facing material is found in the coffee filter (see Figure 13), the oil-cooler is not serviceable. The radiator/oil cooler must be replaced.

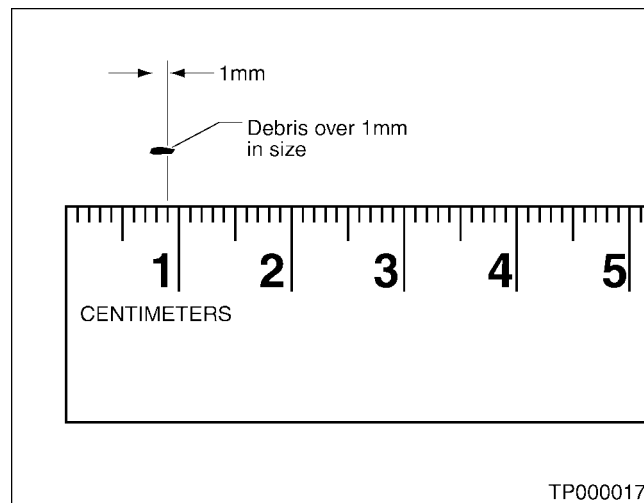

Figure 13

### Final Inspection:

After performing all procedures, ensure that all remaining oil is cleaned from all components.

## PARTS INFORMATION

DESCRIPTION	PART #	QUANTITY
Transmission Cooler Cleaner *	999MP-AM006	As Needed

Nissan Transmission Cooler Cleaner and all chemicals are ordered through the Nissan Direct Ship Chemical Care Product Program: Phone 1.800.811.0502, Fax1.904.389.8279, Website [www.NissanChemicals.com](http://www.NissanChemicals.com).

\* Material Safety Data Sheets for this product are attached (Attachment A) or ASIST users click [here](#).

## CLAIMS INFORMATION

Use the following "Combination" Op Codes as indicated with the appropriate Section "JA", "JC", or "JD" coding that best represents the A/T R&R and repair/replacement performed:

DESCRIPTION	PFP	OP CODE	SYM	DIA	FRT
<b>Combination:</b> Water-cooled A/T oil cooler cleaning and inspection		JA011A			(1)

(1) Reference the current Nissan Warranty Flat Rate Manual and use the indicated FRT.

OR

DESCRIPTION	PFP	OP CODE	SYM	DIA	FRT
<b>Combination:</b> Water-cooled plus air-cooled A/T oil cooler cleaning and inspection (for certain '96-'98 R50s fitted with <u>both</u> types of A/T coolers)		JA012A			(1)

(1) Reference the current Nissan Warranty Flat Rate Manual and use the indicated FRT.

OR

DESCRIPTION	PFP	OP CODE	SYM	DIA	FRT
<b>Combination:</b> Water-cooled A/T oil cooler cleaning and inspection		JC011A			(1)

(1) Reference the current Nissan Warranty Flat Rate Manual and use the indicated FRT.

OR

DESCRIPTION	PFP	OP CODE	SYM	DIA	FRT
<b>Combination:</b> Water-cooled A/T oil cooler cleaning and inspection		JD011A			(1)

(1) Reference the current Nissan Warranty Flat Rate Manual and use the indicated FRT.